

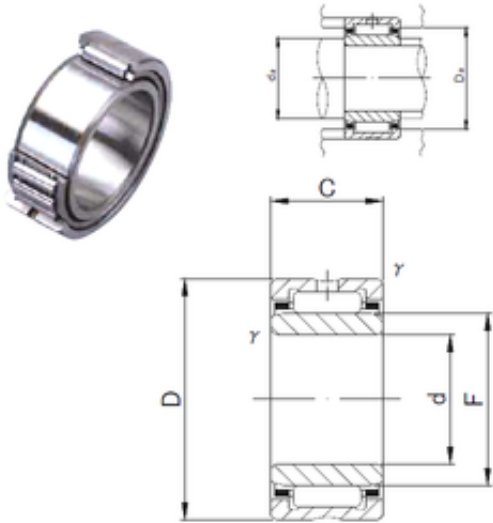

Bearing Manufacturing of America



15 mm x 28 mm x 18 mm 15 mm x 28 mm x 18 mm JNS NA 5902 needle roller bearings

Bearing No. NA 5902

Dimensione	15x28x18 mm
Marchio	JNS
Diametro del foro	15 mm
Diametro esterno	28 mm
Larghezza	18 mm
d	15 mm
F	20 mm
D	28 mm
B	18 mm
C	18 mm
r min.	0,3 mm
da min.	17 mm
da max	19 mm
Da max.	26 mm
Peso	0,052 Kg
Carico dinamico di base (C)	15,7 kN
Carico statico di base (C0)	22,1 kN

NA 5902 Bearing 2D drawings and 3D CAD models